

## SCHOTTKY DIODES

### FEATURES

Extremely Fast Switching Speed

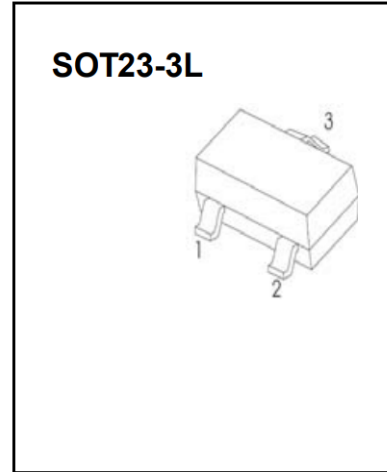
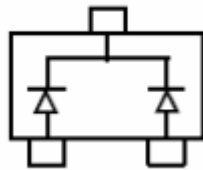
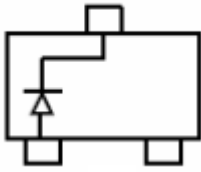

BAT54 MARKING: KL1

BAT54C MARKING: KL2

### Maximum Ratings @T<sub>A</sub>=25°C

| Parameter                            | Symbol           | Limits  | Unit |
|--------------------------------------|------------------|---------|------|
| Peak Repetitive Peak reverse voltage | V <sub>RRM</sub> | 30      | V    |
| Working Peak Reverse Voltage         | V <sub>RWM</sub> |         |      |
|                                      | V <sub>R</sub>   |         |      |
| Forward Continuous Current           | I <sub>FM</sub>  | 200     | mA   |
| Power Dissipation                    | P <sub>D</sub>   | 200     | mW   |
| Storage temperature                  | T <sub>STG</sub> | -55-150 | °C   |

### Electrical Characteristics @T<sub>A</sub>=25°C

| Parameter                 | Symbol             | Min. | Typ. | Max. | Unit | Conditions  |
|---------------------------|--------------------|------|------|------|------|---|
| Reverse Breakdown Voltage | V <sub>(BR)R</sub> | 30   |      |      | V    | I <sub>R</sub> =100μA   |
| Forward voltage           | V <sub>F1</sub>    |      |      | 0.24 | V    | I <sub>F</sub> =0.1mA   |
|                           | V <sub>F2</sub>    |      |      | 0.32 | V    | I <sub>F</sub> =1mA   |
|                           | V <sub>F3</sub>    |      |      | 0.40 | V    | I <sub>F</sub> =10mA  |
|                           | V <sub>F4</sub>    |      |      | 0.50 | V    | I <sub>F</sub> =30mA  |
|                           | V <sub>F5</sub>    |      |      | 1    | V    | I <sub>F</sub> =100mA   |
| Reverse current           | I <sub>R</sub>     |      |      | 2    | μA   | V <sub>R</sub> =25V   |
| Diode Capacitance         | C <sub>D</sub>     |      |      | 15   | pF   | V <sub>R</sub> =1V, f=1MHz  |
| Reverse Recovery Time     | t <sub>rr</sub>    |      |      | 5    | nS   | I <sub>F</sub> =I <sub>R</sub> =10mA<br>I <sub>rr</sub> =0.1X I <sub>R</sub> , R <sub>L</sub> =100Ω |

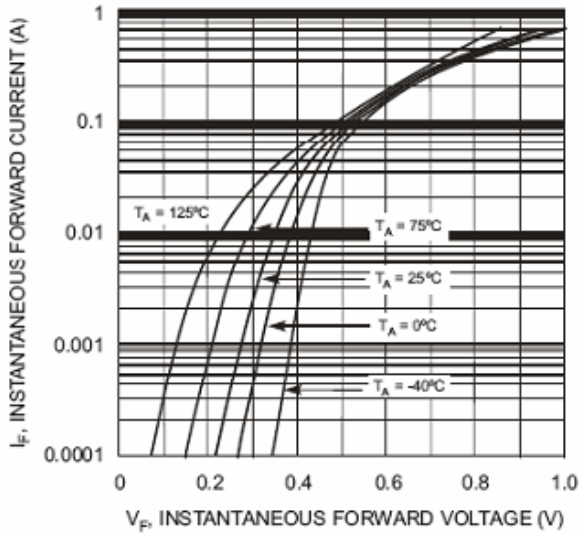

Fig. 1 Forward Characteristics

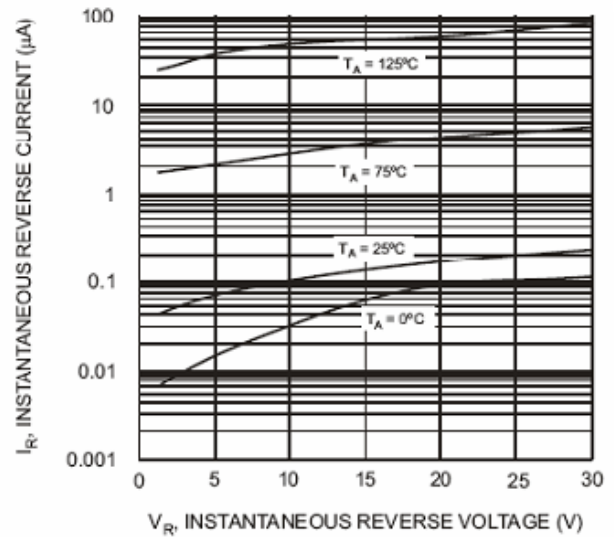

Fig. 2 Typical Reverse Characteristics

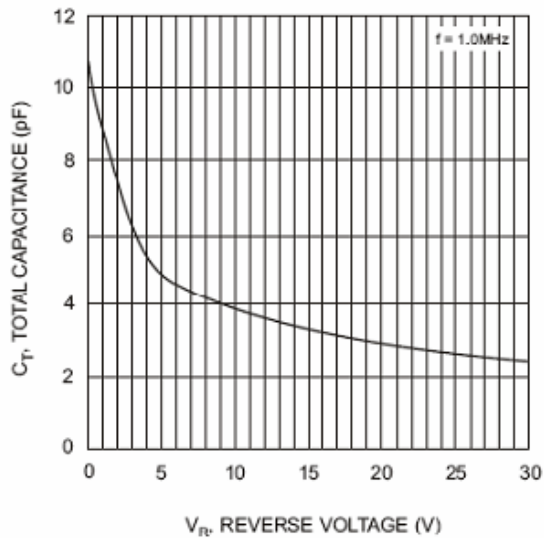

Fig. 3 Typical Capacitance vs. Reverse Voltage

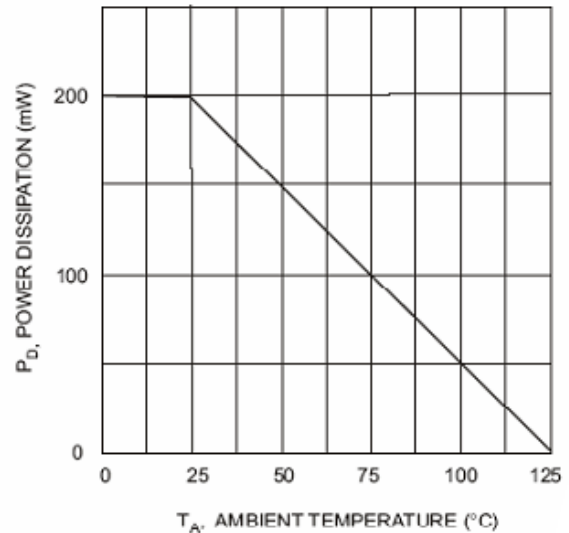
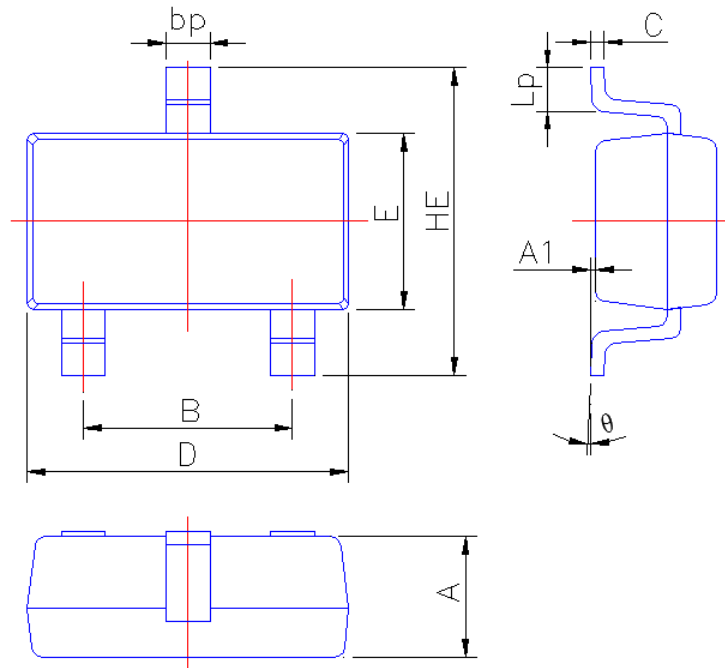

Fig. 4 Power Derating Curve

## SOT-23-3L-Package Outline Dimensions



| Symbol | Dimension in Millimeters |       |
|--------|--------------------------|-------|
|        | Min                      | Max   |
| A      | 1.05                     | 1.20  |
| A1     | 0.010                    | 0.100 |
| B      | 1.80                     | 2.00  |
| bp     | 0.35                     | 0.50  |
| C      | 0.09                     | 0.15  |
| D      | 2.80                     | 3.00  |
| E      | 1.50                     | 1.70  |
| HE     | 2.60                     | 3.00  |
| Lp     | 0.25                     | 0.55  |
| θ      | 2°                       | 6°    |